

Montážny návod

TEMPO
KONDELA

1/1

D80ZL-

Je potrebné použiť kladivo a šraubovák.

Promo

Skrinky montujte podľa krokov v montážnom návode.

260cm

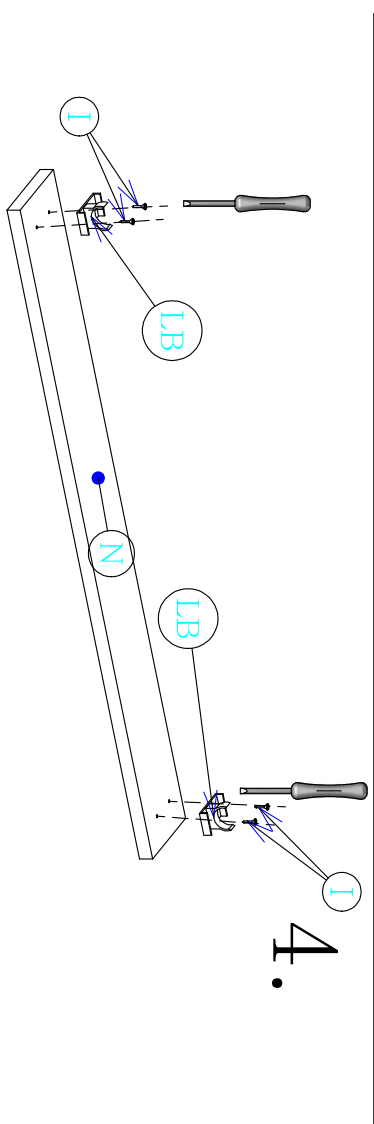
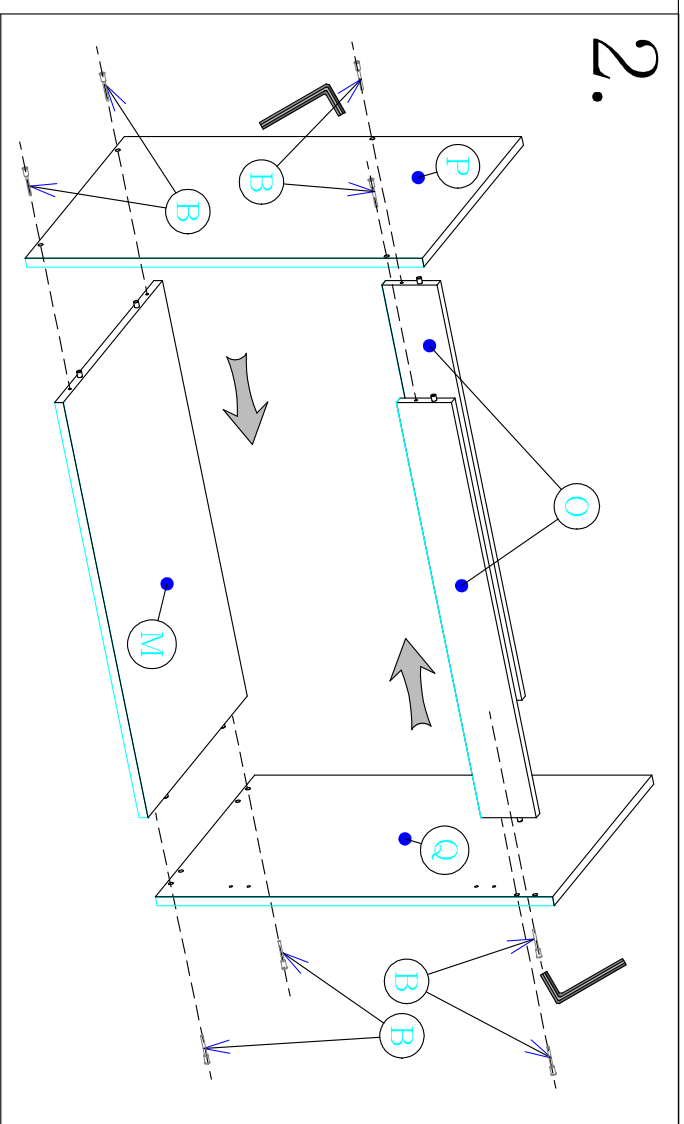
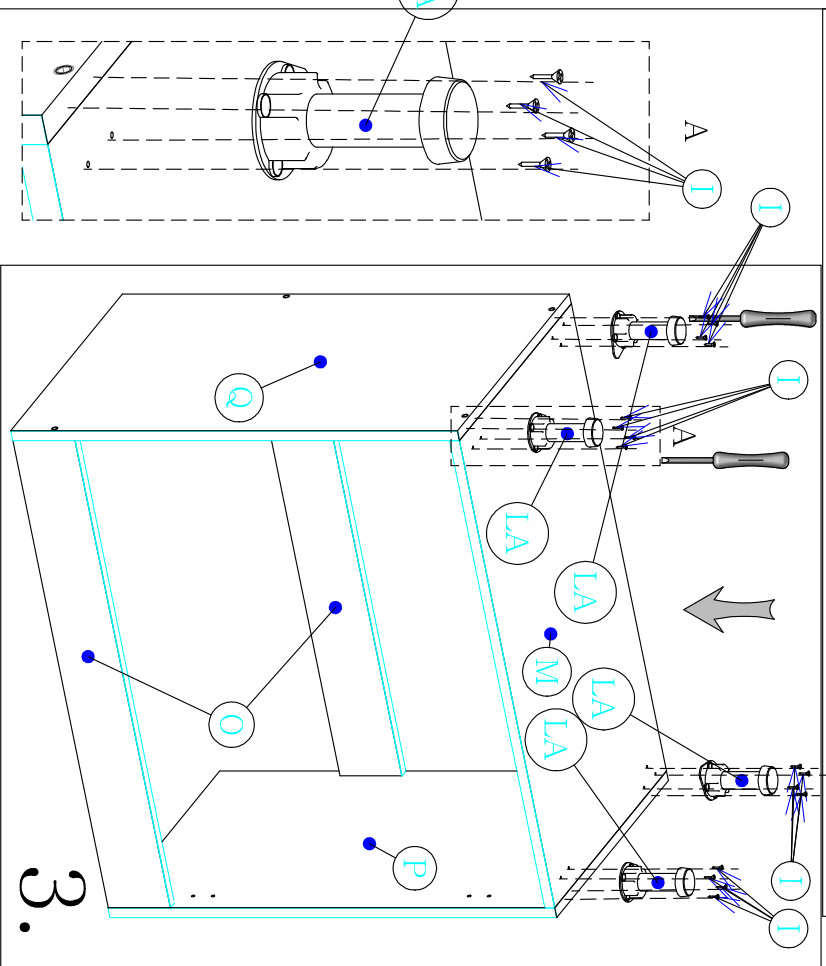
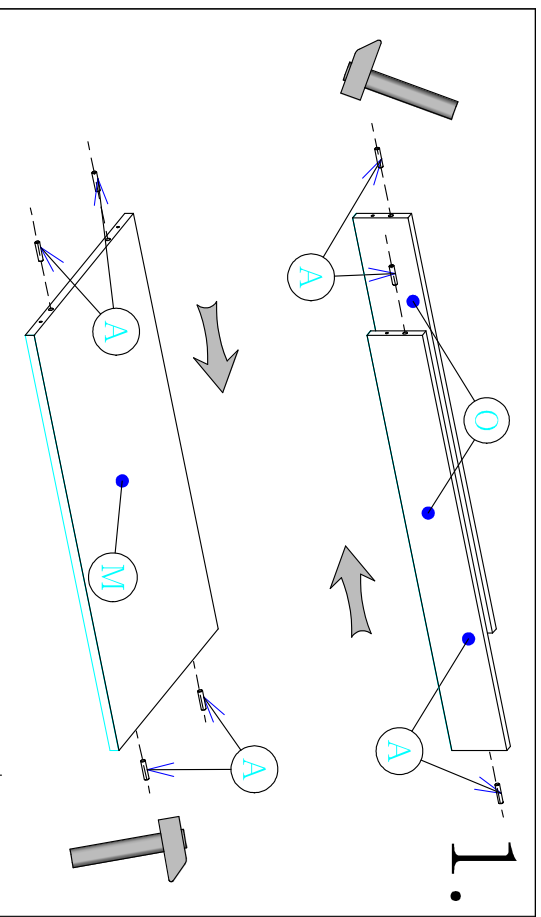

Montážny návod			1/2
D80ZL	Je potrebné použiť kladivo a šraubovák.		
Promo	Skrinky montujte podľa krokov v montážnom návode.		
260cm			

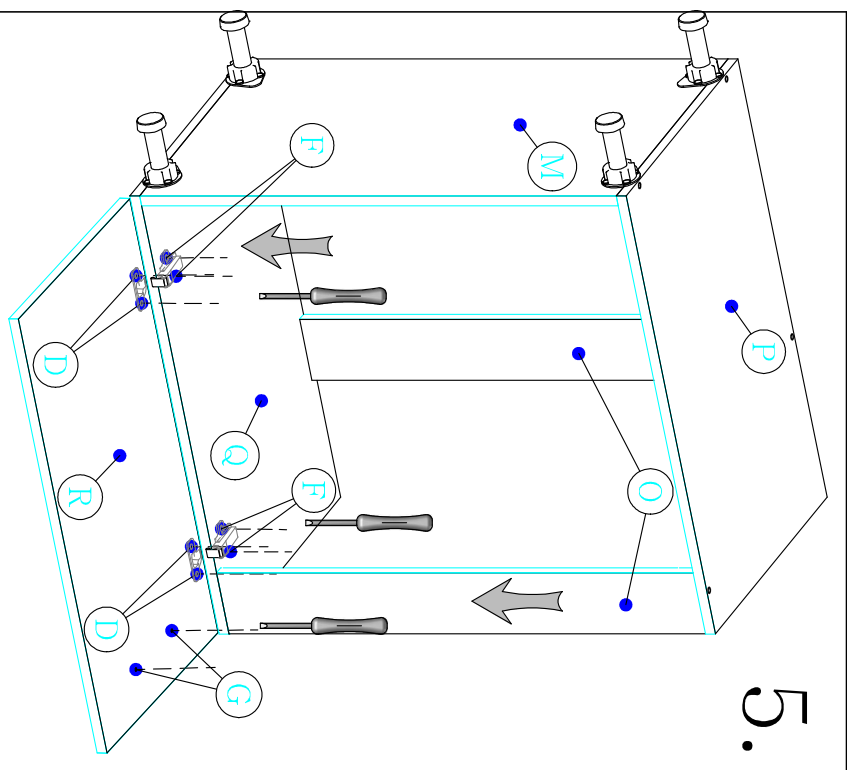

5.

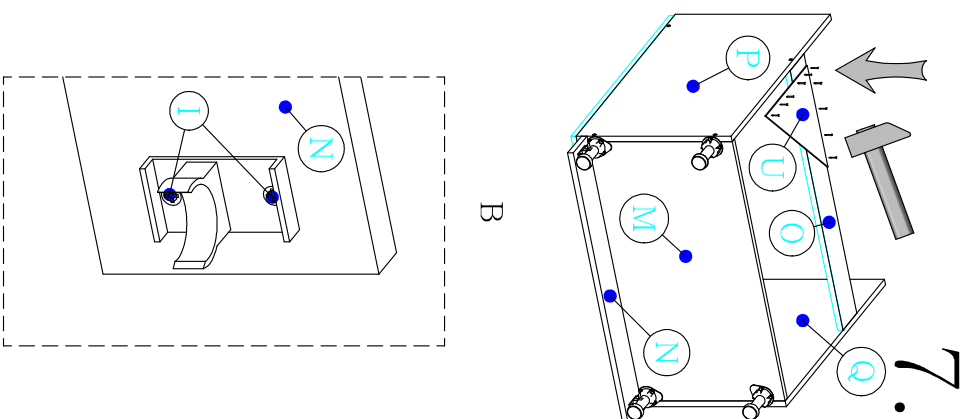

7.

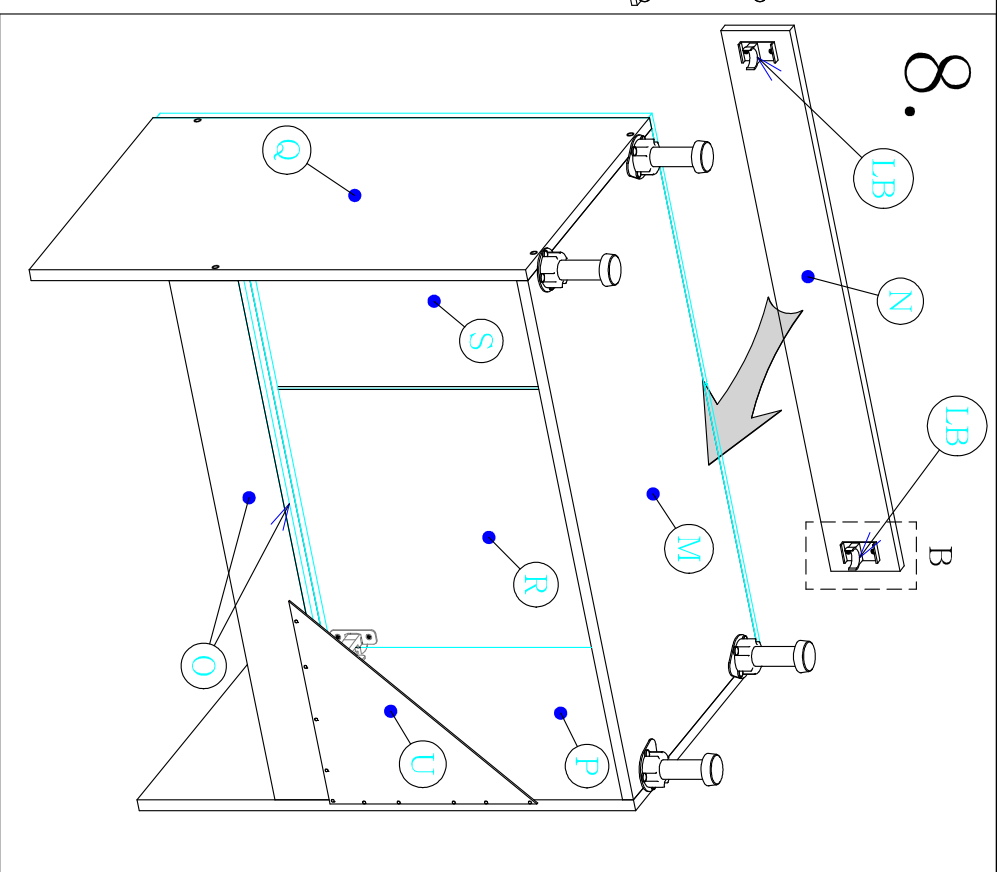

8.

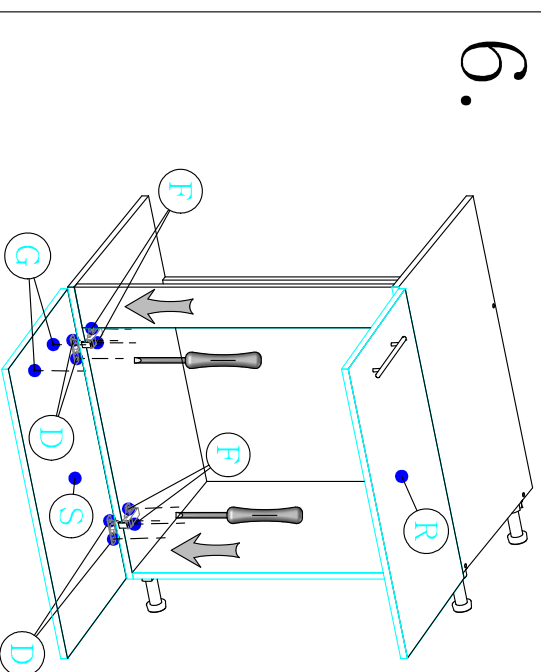

6.

Montážny návod			2/2
D80ZL	Promo		
260cm		Skrinky montujte podľa krokov v montážnom návode.	