

Vysoká komoda

MATEO

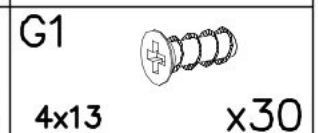

I

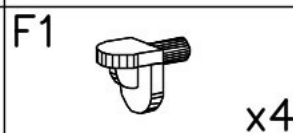
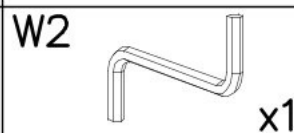
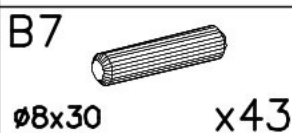
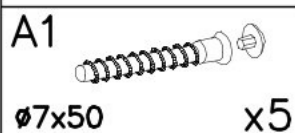
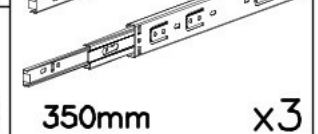
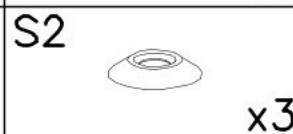
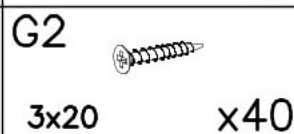
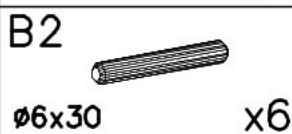
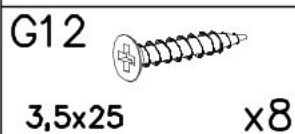
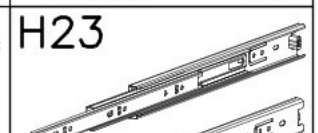
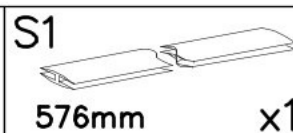
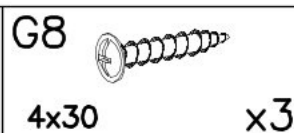
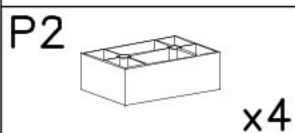
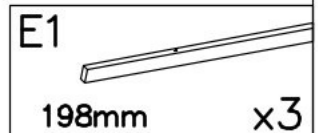
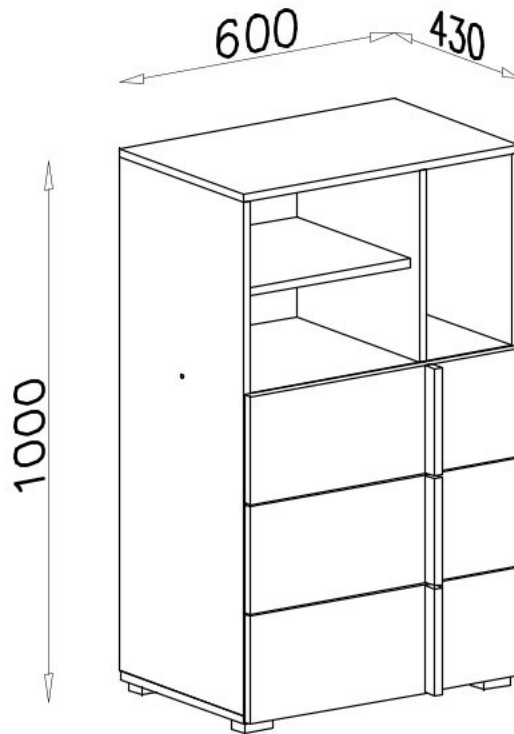
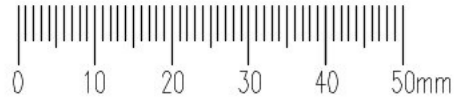
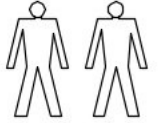
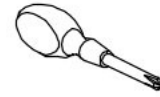
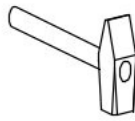
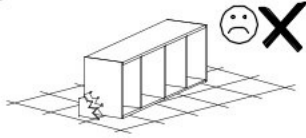
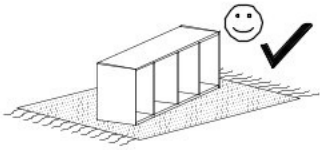
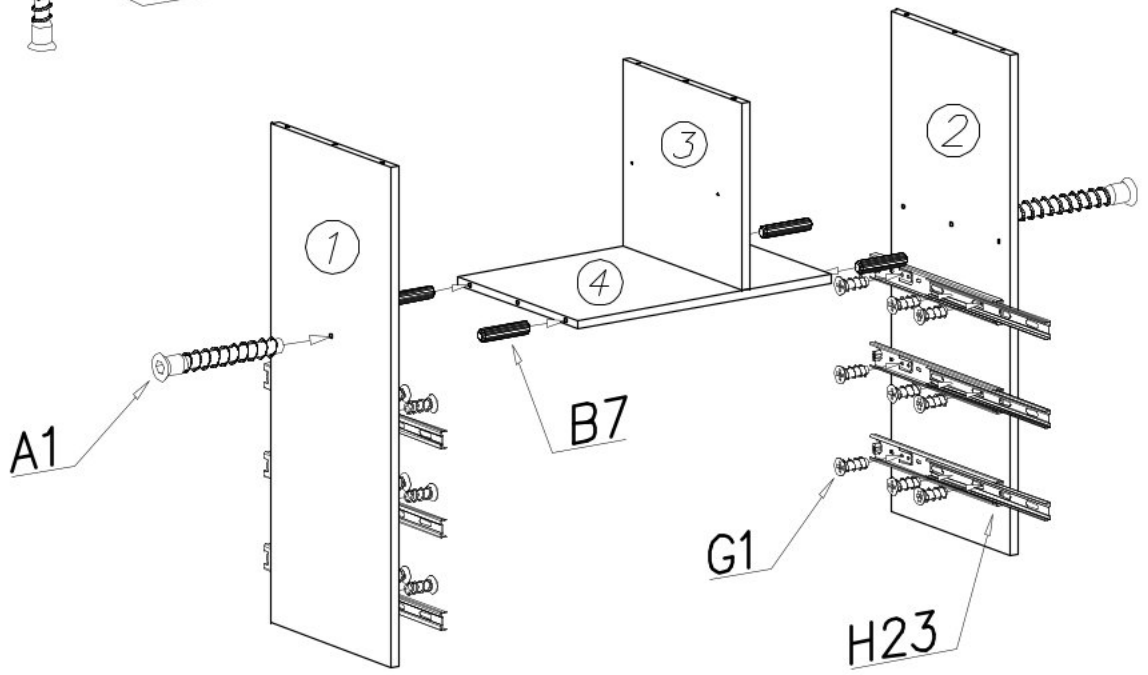
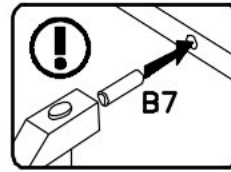
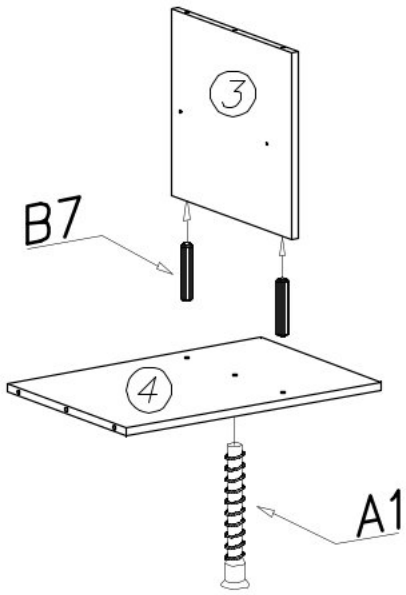

A



B

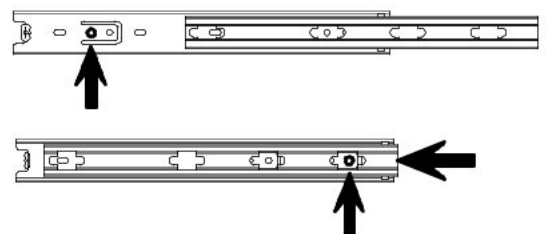
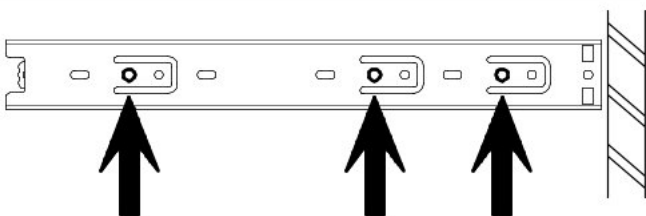
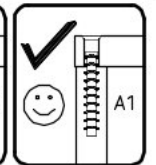
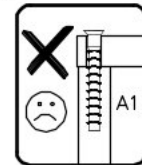
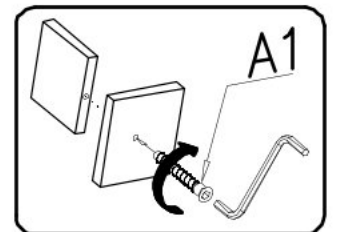
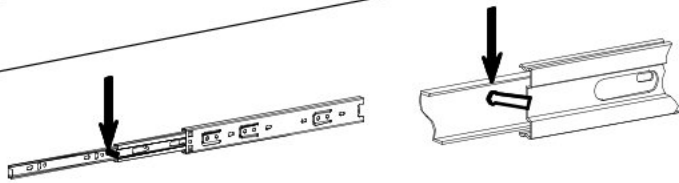

II

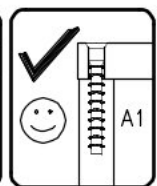
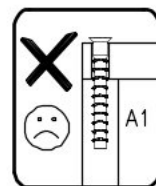
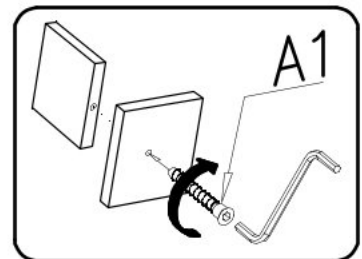
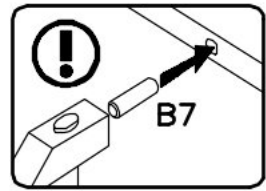
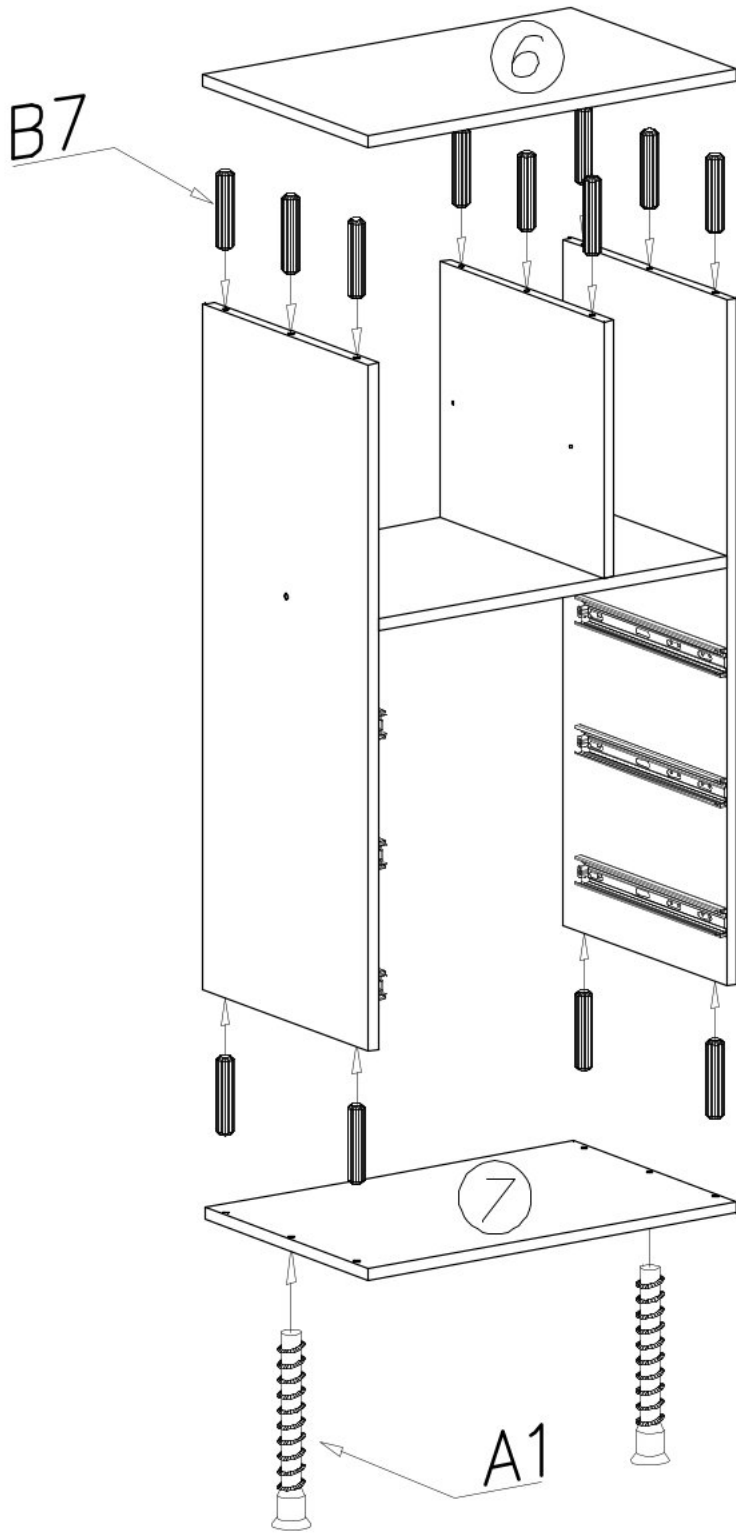

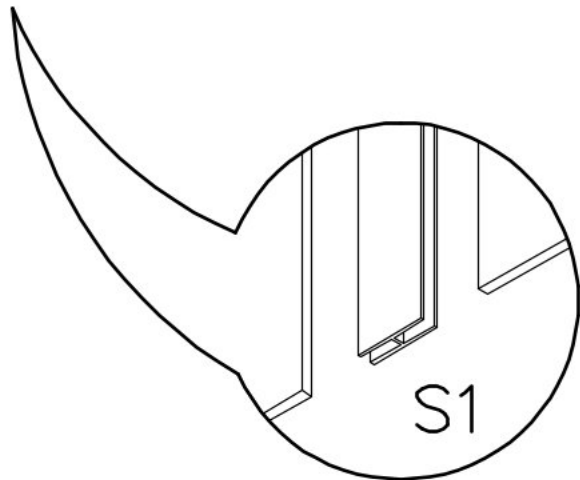
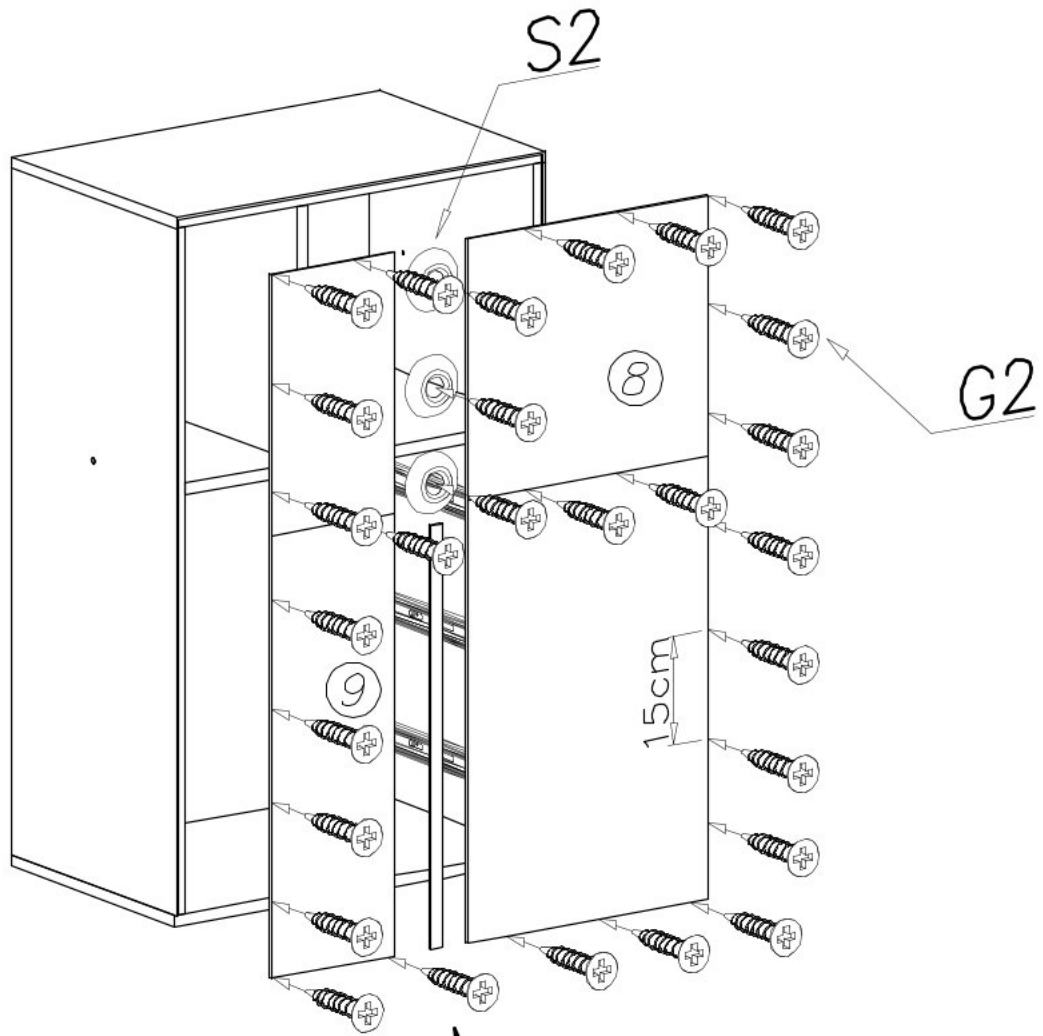
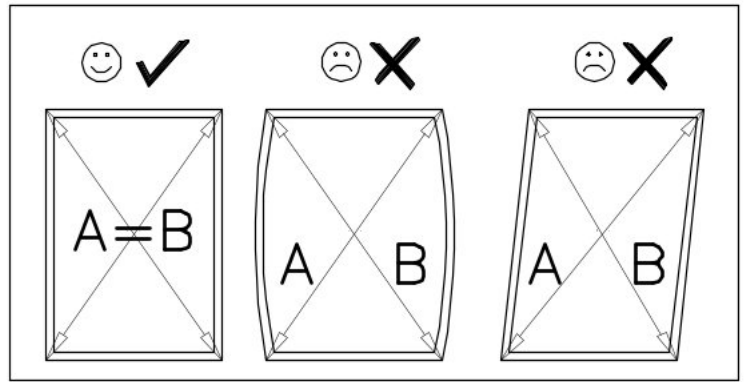

IV

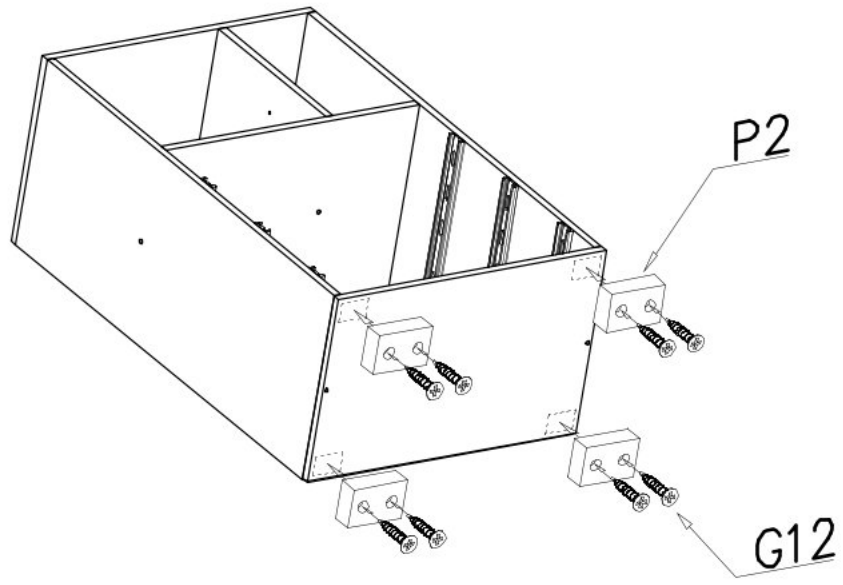

V

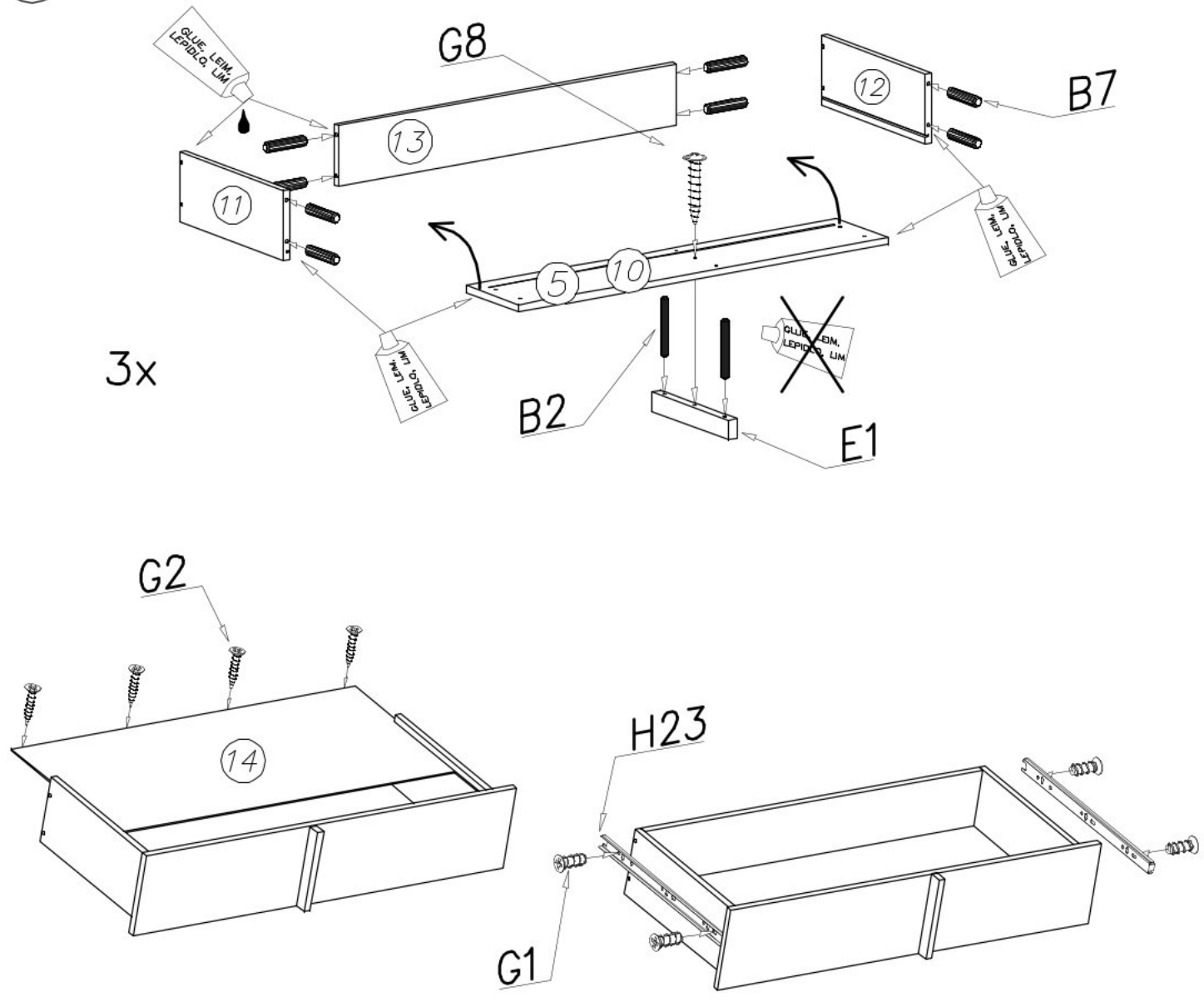

VI

