

UPUTSTVO ZA MONTIRANJE
ASSEMBLING INSTRUCTION
MONTAGEANLEITUNG
INSTRUCTIONS D'ASSEMBLAGE
INSTRUCCIONES DE MONTAJE

ISTRUZIONI PER L'INSTALLAZIONE
ИНСТРУКЦИЯ ПО МОНТАЖУ
MONTÁŽNÍ NÁVOD
ΟΔΗΓΙΕΣ ΣΥΝΑΡΜΟΛΟΓΗΣΗΣ
INSTRUCȚIUNI DE MONTAJ

ИНСТРУКЦИЯ ЗА МОНТАЖ
SZERELÉSI UTASÍTÁS
NAVODILA ZA MONTAŽO
UPUTE ZA MONTAŽU
UPUTSTVO ZA MONTIRANJE

УПАТСТВО ЗА МОНТИРАЊЕ
UDHËZIMET PËR MONTIM
INSTRUKCJA MONTAŻU
INSTRUÇÕES DE MONTAGEM
MONTAGE INSTRUCTIE



Čtyřdveřová šatní skříň se zrcadlem a zásuvkou GERALT

* **RS ME** Naznačeno vreme montaže važi za stručno obučena lica (profesionalne montažere)/**UK** The specified installation time applies to professionally trained persons (professional installers)/**DE AT CH** Die bezeichnete Zeit der Montage gilt für fachlich geschulte Personen (professionelle Monteur) / **FR CH** Le temps d'installation spécifique s'applique aux personnes formées professionnellement (installateurs professionnels) / **ES** El tiempo de instalación especificado se refiere a personas profesionalmente capacitadas (instaladores profesionales) / **IT CH** tempo di installazione indicato vale per le persone professionalmente preparate (installatori professionali) / **RUS** Приведённое время монтажа действительно для специально обученных лиц (профессиональных монтажников) / **CZ** Uvedená doba montáže se vztahuje na odborně způsobilé osoby (profesionální montér) / **EL** Ο αναφερόμενος χρόνος εγκατάστασης ισχύει για εκπαιδευμένα άτομα (επαγγελματίες εγκαταστάτες) / **RO** Timpul de instalare specificat se aplică persoanelor instruite profesional (instalatori profesioniști) / **BG** Посоченото време за монтаж се отнася за професионално обучени лица (професионални монтажници) / **HU** Az összeszerelés megjelölt ideje a szakképzett személyekre vonatkozik (hivatásos összeszerelők) / **SL** Navedeni čas namestitve (montaže) velja za strokovno usposobljene osebe (strokovne monterje) / **HR** Navedeno vrijeme montaže odnosi se na stručno osposobljene osobe (profesionalne montažere) / **BIH** Naznačeno vrijeme montaže važi za stručno obučena lica (profesionalne montažere) / **MK** Назначено време за монтажа важи за стручно обучени лица (професионални монтажери) / **AL** Koha e specifikuar e instalimit zbatohet në rast të personave me trajnim profesional (instalues profesionistë) / **PL** Zaznaczony czas montażu dotyczy przeszkolonych zawodowo osób (profesjonalnych monterów) / **PT** O tempo de montagem indicado aplica-se a pessoas profissionalmente treinadas (instaladores profissionais) / **NL BE** De aangegeven installatietijd is geldig voor professioneel opgeleide personen (professionele installateurs).

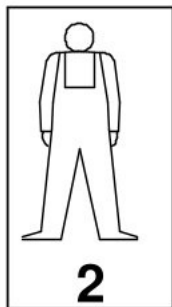

2

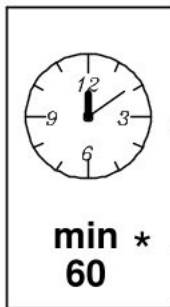

min *
60

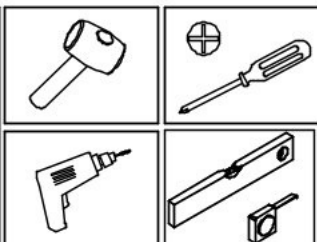

RS ME PRE POČETKA MONTIRANJA OBAVEZNO PROČITAJTE UPUTSTVO ZA MONTAŽU / **UK** BEFORE STARTING, REFER TO THE ASSEMBLING ADVICE IN ANNEX / **DE AT CH** VOR DER MONTAGE BITTE BEILIEGENDE ANWEISUNGEN LESEN / **FR CH** AVANT LE DÉBUT DE L'ASSEMBLAGE, S'IL VOUS PLAÎT, LISEZ L'INSTRUCTION D'ASSEMBLAGE / **ES** ANTES DE EMPEZAR EL MONTAJE, LEER CUIDADOSAMENTE LAS INSTRUCCIONES DEL ANEXO / **IT CH** PRIMA DI INIZIARE L'INSTALLAZIONE SI RACCOMANDA DI LEGGERE LE ISTRUZIONI DI INSTALLAZIONE / **RUS** ДО НАЧАЛА МОНТАЖА ОЗНАКОМЬТЕСЬ С ИНСТРУКЦИЕЙ / **CZ** SEZNAMTE SE S NÁVODEM PŘED MONTÁŽÍ NÁBYTKU / **EL** ΠΡΙΝ ΕΚΙΝΗΣΕΤΕ ΤΗ ΣΥΝΑΡΜΟΛΟΓΗΣΗ, ΟΠΩΣΔΗΠΟΤΕ ΔΙΑΒΑΣΤΕ ΤΙΣ ΟΔΗΓΙΕΣ ΣΥΝΑΡΜΟΛΟΓΗΣΗΣ / **RO** ÎNAINTE DE ÎNCERPEREA MONTAJULUI ESTE OBLIGATORIE CITIREA INSTRUCȚIUNILOR / **BG** ПРЕДИ МОНТИРАНЕ НЕ ЗАБРАВЯЙТЕ ДА СЪ ЧЕТЕ ИНСТРУКЦИИ ЗА МОНТАЖ / **HU** SZERELÉS ELŐTT OKVETLENÜL OLVASSA EL A HASZNÁLATI UTASÍTÁST / **SL** PRED ZAČETKOM MONTAŽE OBEVZNO PREBERITE NAVODILA / **HR** PRIJE MONTAŽE UPOZNATI SE SA UPUTSTVOM / **BIH** PRE POČETKA MONTIRANJA OBAVEZNO PROČITAJTE UPUTSTVO ZA MONTAŽU / **MK** ПРЕД ПОЧЕТОК НА МОНТИРАЊЕ ЗАДОЛЖИТЕЛНО ДА СЕ ПРОЧИТА УПАТСТВОТО ЗА МОНТИРАЊЕ / **AL** PARA FILLIMIT TË MONTIMIT LEXONI PATJETËR UDHËZIMIN PËR MONTIM / **PL** PRZED ROZPOCZĘCIEM MONTAŻU PROSZĘ ZAPOZNAĆ SIĘ Z INSTRUKCJĄ / **PT** ANTES DE INICIAR A MONTAGEM, CERTIFIQUE-SE DE LER AS INSTRUÇÕES DE MONTAGEM / **NL BE** LEES DE MONTAGE INSTRUCTIE VOORDAT U MET DE INSTALLATIE BEGINT

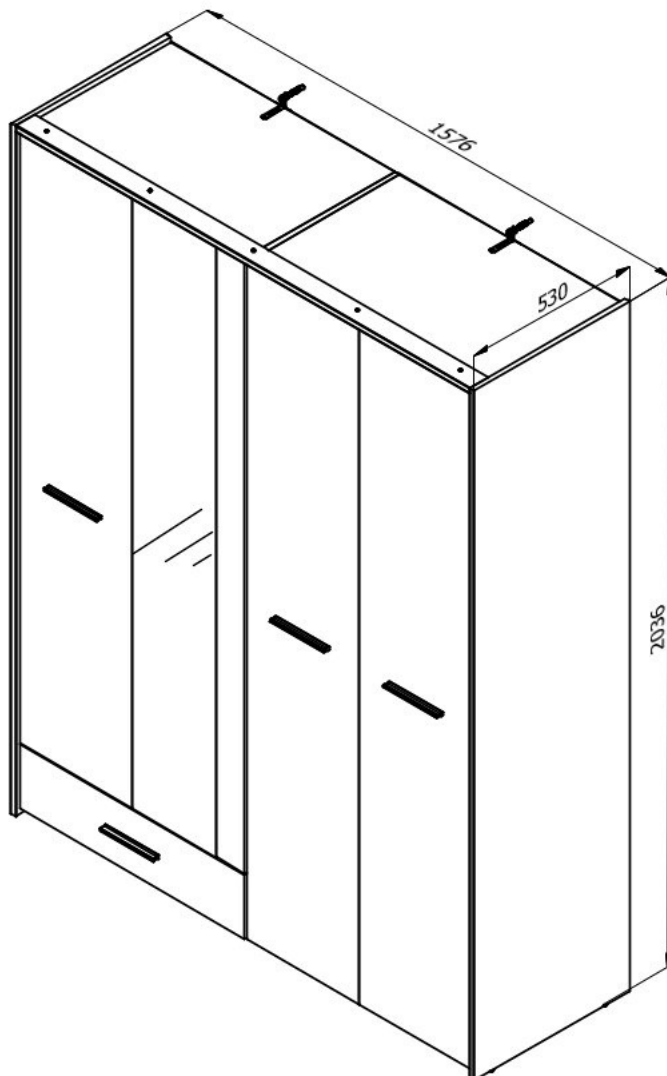

38602	454 mm	763 mm	16 mm	3
38605	382 mm	1996 mm	16 mm	2
38608	1998 mm	780 mm	3 mm	2
38797	382 mm	1804 mm	16 mm	1
39257	530 mm	2032 mm	16 mm	1
39258	530 mm	2032 mm	16 mm	1
39259	1544 mm	66 mm	16 mm	1
39597	500 mm	764 mm	16 mm	6
39598	500 mm	2000 mm	16 mm	1
39629	764 mm	116 mm	16 mm	1
39631	1804 mm	382 mm	20 mm	1
39672	764 mm	116 mm	16 mm	1
29793	700 mm	100 mm	16 mm	1
31093	400 mm	100 mm	16 mm	2
38802	730 mm	404 mm	3 mm	1
39547	188 mm	768 mm	16 mm	1

Package 1/3	
38608	2
39257	1
39258	1
39259	1
39598	1





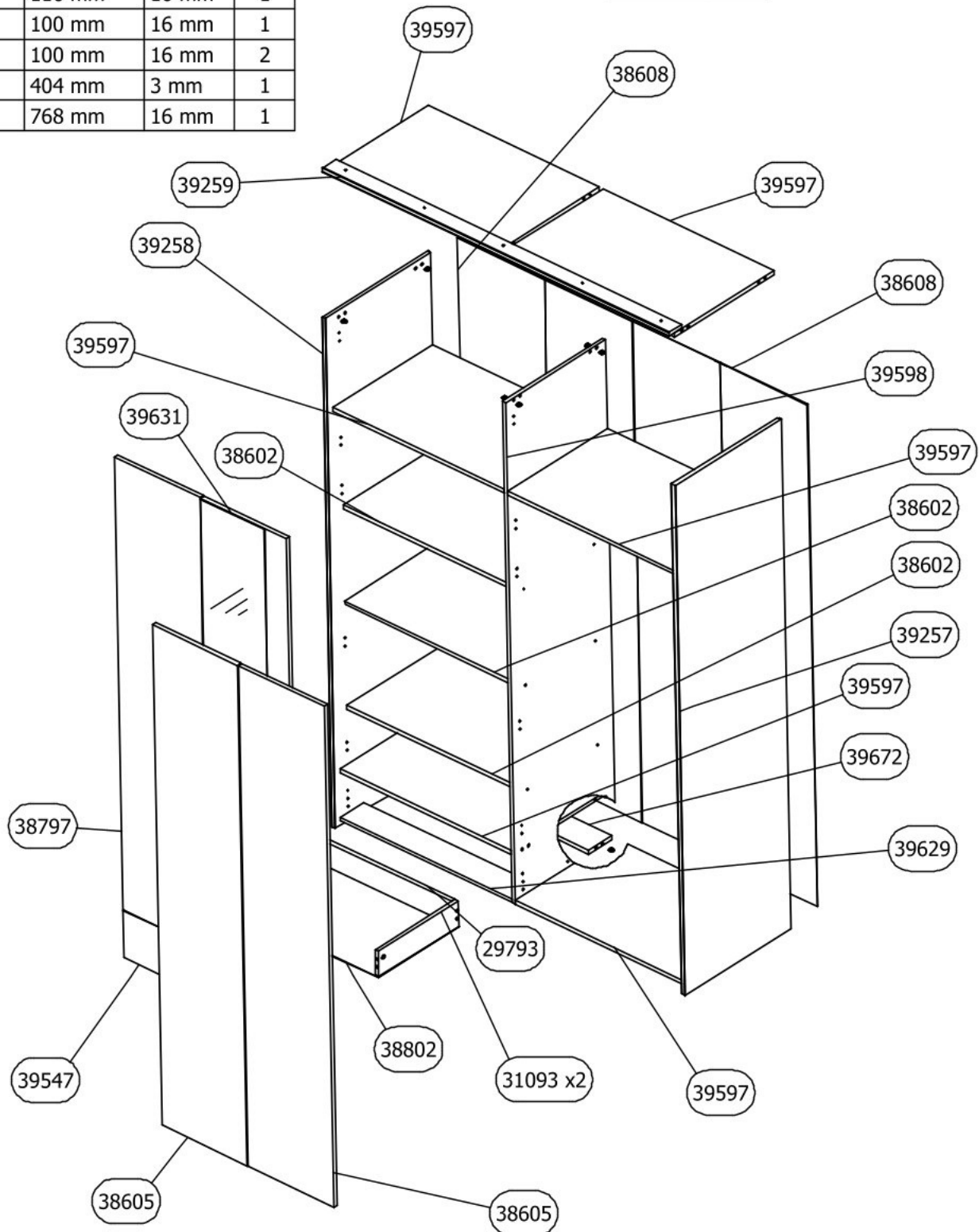



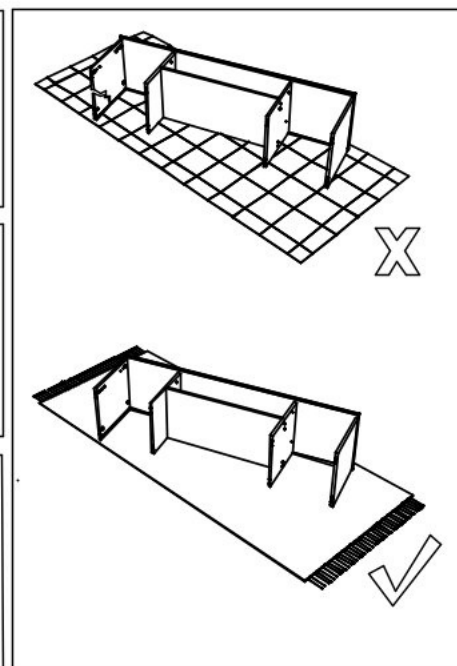
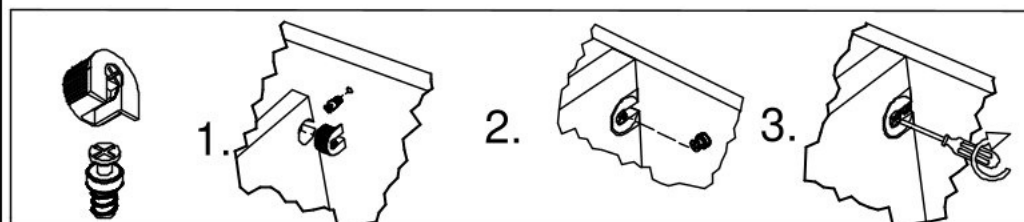
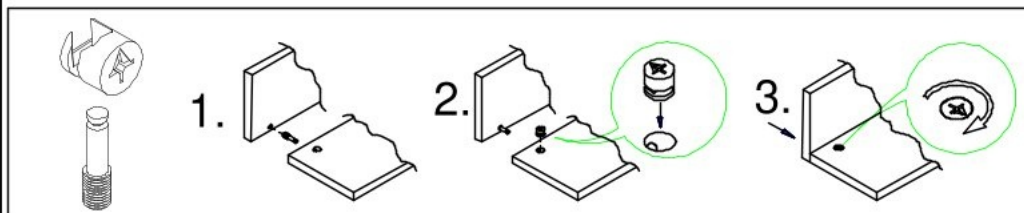
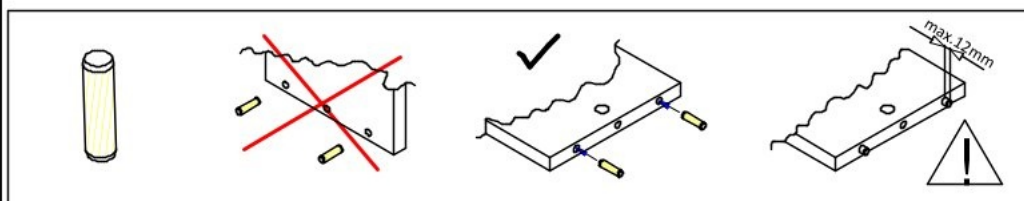

























Package 2/3	
29793	1
31093	2
38602	3
38802	1
39597	6
39629	1
39672	1







Package 3/3	
38605	2
38797	1
39547	1
39631	1











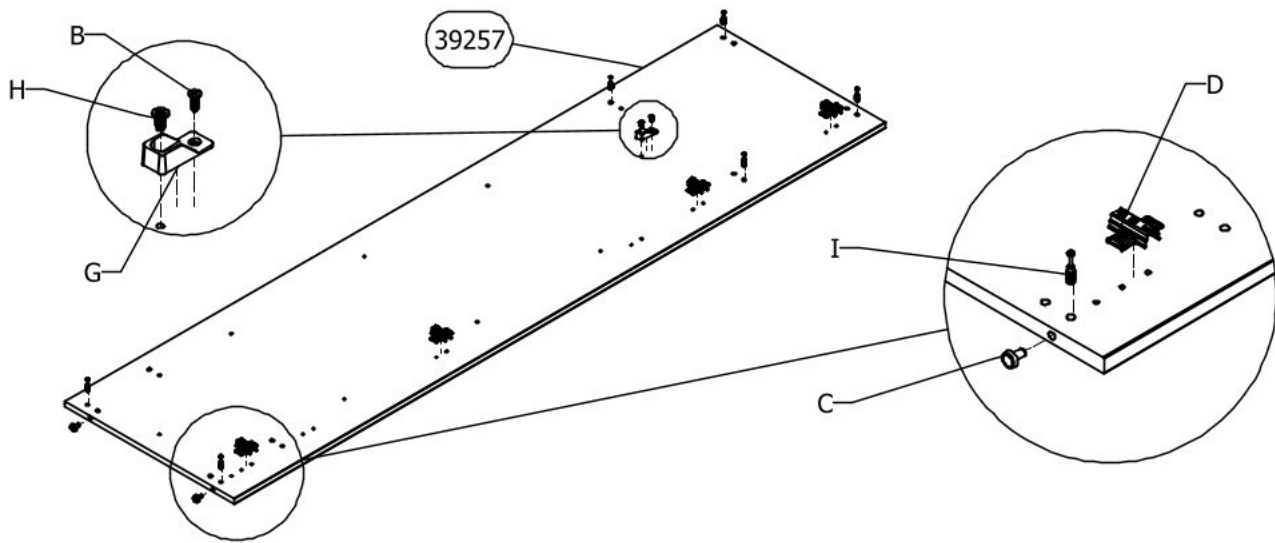

RS ME 1. Montažu obavljati na čistoj i mekoj podlozi (karton, tkanina...) 2. Da bi izbegli oštećenja elemenata pridržavati se datih instrukcija. 3. Prilikom prijave reklamacije koristiti date oznake elemenata.	FR CH 1. Effectuer l'assemblage sur une surface propre et douce (carton, tissu...) 2. Afin d'éviter l'endommagement des éléments, respectez les instructions données. 3. Lors de l'application de réclamation, utiliser les désignations données des éléments.
DE AT CH 1. Die Montage soll auf sauberer, weicher Fläche durchgeführt werden (Karton, Stoff) 2. Um die Beschädigung der Elemente zu vermeiden, befolgen Sie bitte die angegebenen Instruktionen 3. Bei Reklamationsmeldungen benutzen Sie bitte die angegebenen Kennzeichen der Elemente	UK 1. Assembly of the product should be done on a clean and soft surface (cardboard, fabric) 2. To prevent damage of the product, it is necessary to adhere to the assembly instructions 3. While reporting defective products, please quote codes in manual
ES 1. Realizar el montaje sobre una superficie limpia y suave (cartón, paño) 2. Para evitar daños del producto, atenerse a las instrucciones de montaje 3. Para reportar productos defectuosos, refiérase por favor a los códigos del manual	IT CH 1. Eseguire l'installazione su una base morbida (cartone, tessuto). 2. Seguire le istruzioni per evitare di causare danni agli elementi. 3. In caso della presentazione di reclamo si utilizzano relative indicazioni degli elementi.
RO 1. Montarea se efectueaza pe o suprafata moale si curata (karton, material...) 2. Respectati instructiunile pentru a evita deteriorarea pieselor 3. La transmiterea reclamatiiilor a se folosi inscriptiile date ale pieselor	CZ SK 1. Montáž provádět na čistém a měkkém podkladu (lepenka, látka) 2. Dodržujte přiložené instrukce, abyste předešli poškození součástí 3. Při reklamacič používejte přiložené označení element
EL 1. Η συναρμολόγηση του προϊόντος πρέπει να γίνει σε καθαρή και μαλακή επιφάνεια (χαρτόνι, ύφασμα). 2. Για να μην φθαρούν τα στοιχεία, συμμορφωθείτε με τις οδηγίες που παρέχονται. 3. Κατά τη δήλωση ελαττωματικού προϊόντος, αναφέρετε τους κώδικες των στοιχείων όπως αναφέρονται στο εγχειρίδιο.	RUS BLR 1. Монтаж изделия выполнять на чистой и мягкой поверхности (картон, ткань) 2. Для предотвращения порчи изделий необходимо придерживаться правил монтажа 3. В случае предъявления претензии использовать данные обозначения элементов.
BG 1. Монтажът трябва да бъде извършен върху чиста и мека основа /karton, тъкан/ 2. За да избегнете оцетяване на елементи, спазвайте дадените инструкции 3. При наличие на рекламация, използвайте дадените кодове на елементи	HU 1. A szerelés tisztá es puha felületen (karton, anyag) kell végrehajtani. 2. Károsodásnak elkerülése érdekében tartsa be a megadott utasításokat. 3. Reklamáció esetén hivatkozzon a bútor alkatrészsein megadott jelekre.
SL 1. Montažo opravimo na čisti in mehki podlogi (karton, tkanina) 2. Da bi se ozognili poškodbam elementov, upoštevajte navodila. 3. Pri reklamaciji uporabimo oznake elementov	BIH HR 1. Montažu obavljati na čistoj i mekoj podlozi (karton, tkanina) 2. Da bi izbjegli oštećenja elemenata pridržavati se datih instrukcija 3. Prilikom prijave reklamacije koristiti date oznake elemenata
MK 1. Монтажа да се врши на чиста и мека подлога (karton, ткаенина) 2. За да се избегне оштетување на елементите придржувајте се на дадените инструкции 3. За пријава на рекламиции користете ги дадените ознаки на елементите	AL 1. Montimi të bëhet në sipërfaqe të pastër dhe të butë (karton, pëlhurë) 2. Që t'u shmangeni dëmtimit të elementeve, përmbahuni instrukcioneve të dhëna 3. Me rastin e reklamimit përdorni shenjat e dhëna të elementit
PL 1. Montować należy na czystej i miękkiej powierzchni (karton, tkanina) 2. Aby uniknąć uszkodzenia elementów należy postępować ściśle według instrukcji. 3. Przy zgłaszaniu reklamacji należy posługiwać się załączonymi oznaczeniami elementów.	HR 1. Pažljivo pročitajte upute za montažu 2. Pripremite sve dijelove namještaja 3. Prikupite i provjerite okove za montažu 4. Pripremite potreban alat 5. Pripremite prostor za montažu 6. Počnite montirati 7. Sačuvajte ove ove upute 8. Proizvod je namjenjen isključivo za kućnu uporabu
PT 1. A montagem deve ser feita em uma superfície limpa e macia (papelão, tecido...) 2. Para evitar danos nos elementos, siga as instruções fornecidas. 3. Durante a apresentação de reclamação usar os rótulos dos elementos fornecidos.	
NL BE 1. De installatie moet worden uitgevoerd op een schoon en zacht oppervlak (karton, stof...) 2. Volg de gegeven instructies om schade aan de elementen te voorkomen. 3. Gebruik bij het melden van een klacht de gegeven elementlabels.	









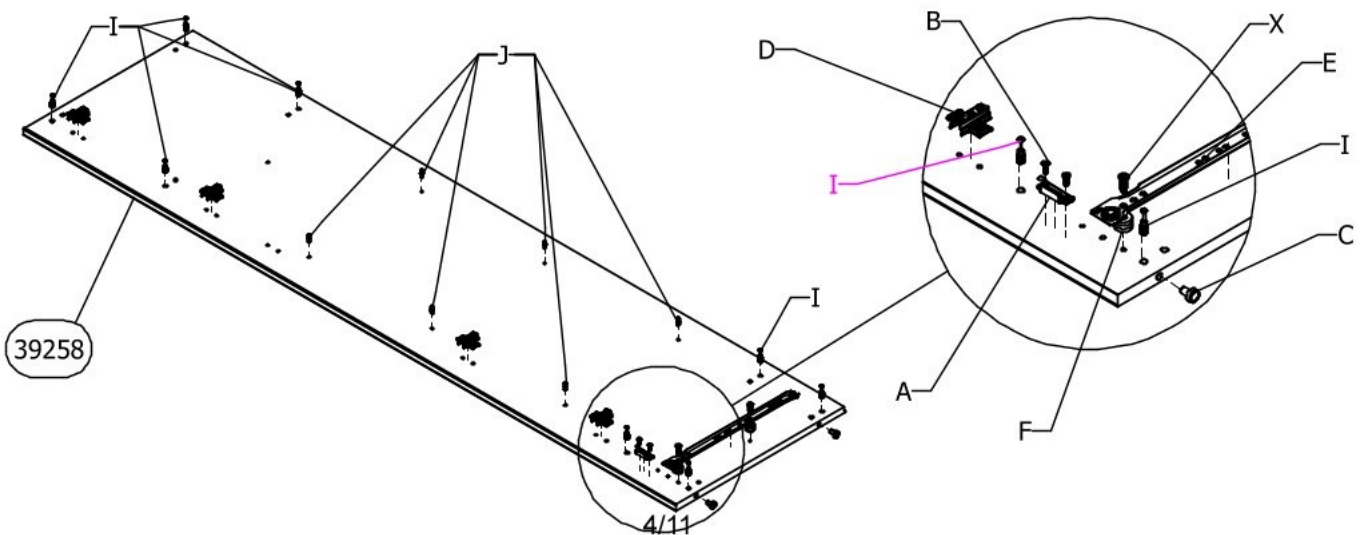

A	B 4x16	C	D	E	F	G	H Ø6.3x13	I	J
									
x1	x8	x4	x8	x1	x4	x2	x4	x18	x12
K Ø8x30	L Ø8x50	M Ø15/12	N	O 4x30	P	Q	R	S	T Ø7x50
									
x20	x6	x30	x6	x13	x8	x8	x4	x8	x2
U	V	W 3x25	X Ø6.3x20	Y	Z 4x30	Aa	Ab 6x60	Ac	Ad
									
x30	x6	x15	x2	x2	x4	x2	x2	x2	x10
Ae 1.6 x 25	Af	Ag	Ah	Ai	Aj	Ak	Al	Am	An
									
x54	x1	x1	x1						

1	C x 2	D x 4	G x 1	H x 1	B x 1	I x 6
						
				Ø6.3x13	4x16	





2	A x 1	B x 2	C x 2	D x 4	I x 8	J x 6	F x 4	E x 1	X x 2
									
		4x16						E1	Ø6.3x20

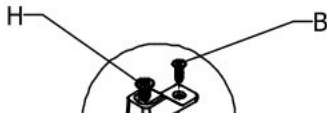

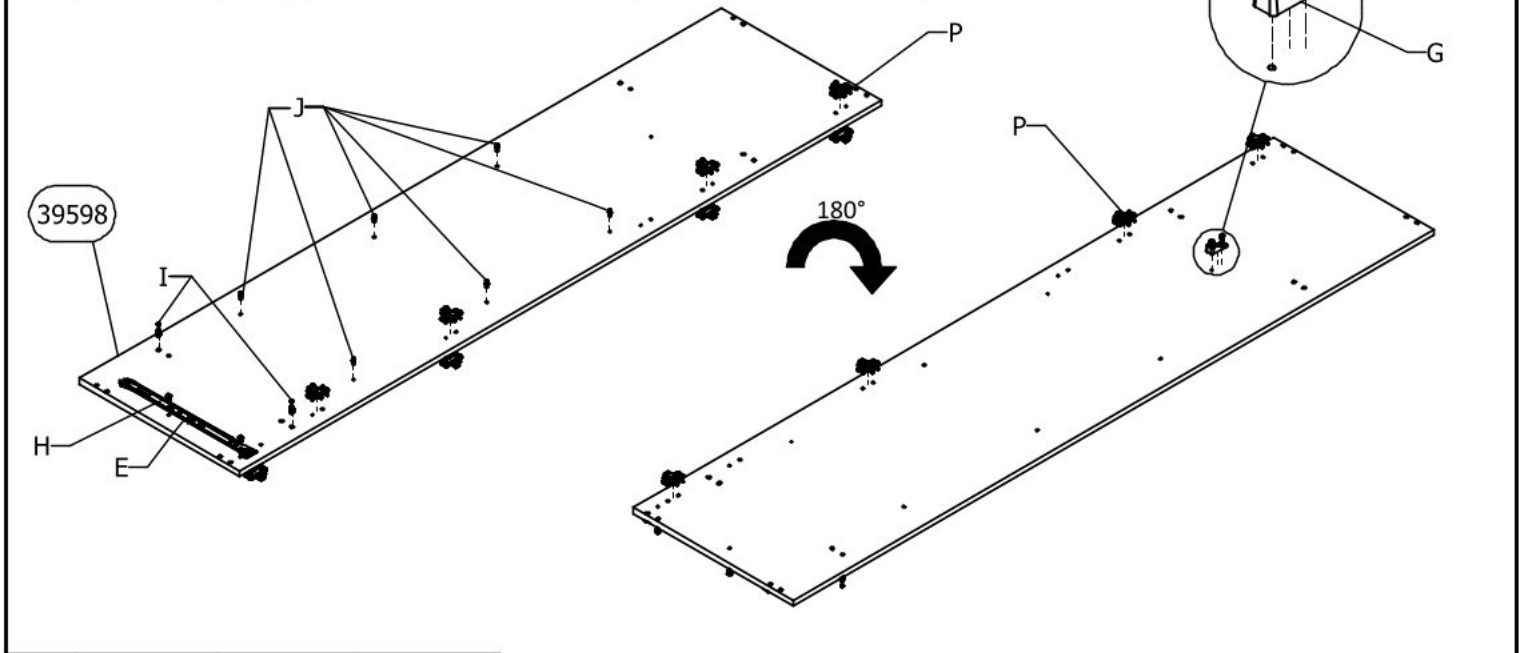

3	G x 1 	H x 3 Ø6.3x13 	B x 1 4x16 	J x 6 	P x 8 	E x 1 E3 	I x 2 	
----------	---	--	---	---	---	---	--	--



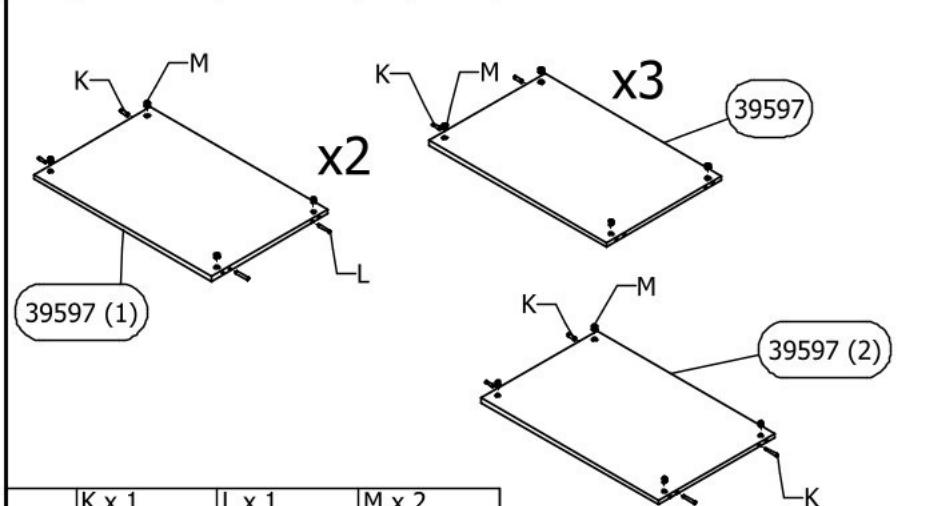

4	K x 14 Ø8x30 	L x 4 Ø8x50 	M x 24 Ø15/12 
----------	--	---	---



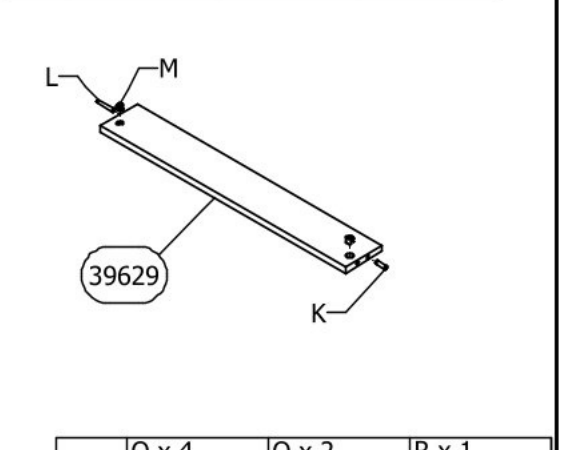

5	M x 2 Ø15/12 	K x 1 Ø8x30 	L x 1 Ø8x50 
----------	--	---	---

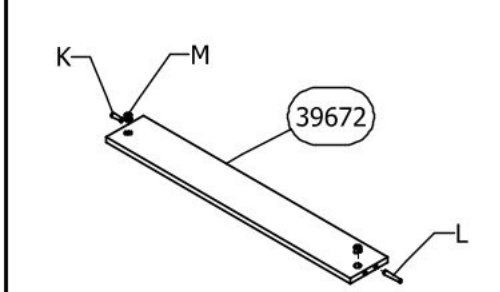

6	K x 1 Ø8x30 	L x 1 Ø8x50 	M x 2 Ø15/12 
----------	---	---	--



7	Q x 4 	O x 2 4x30 	R x 1 
----------	--	--	--

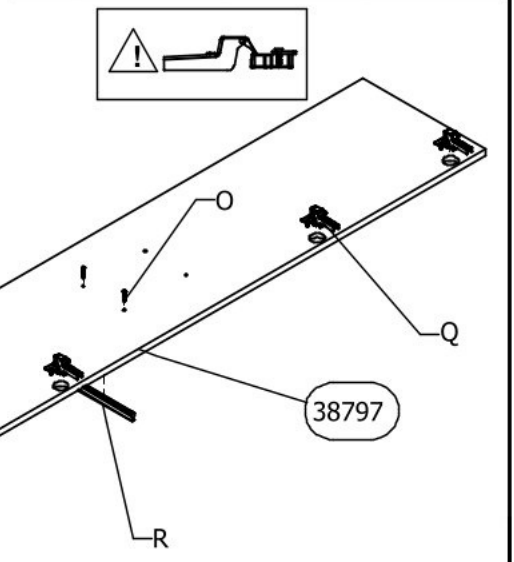

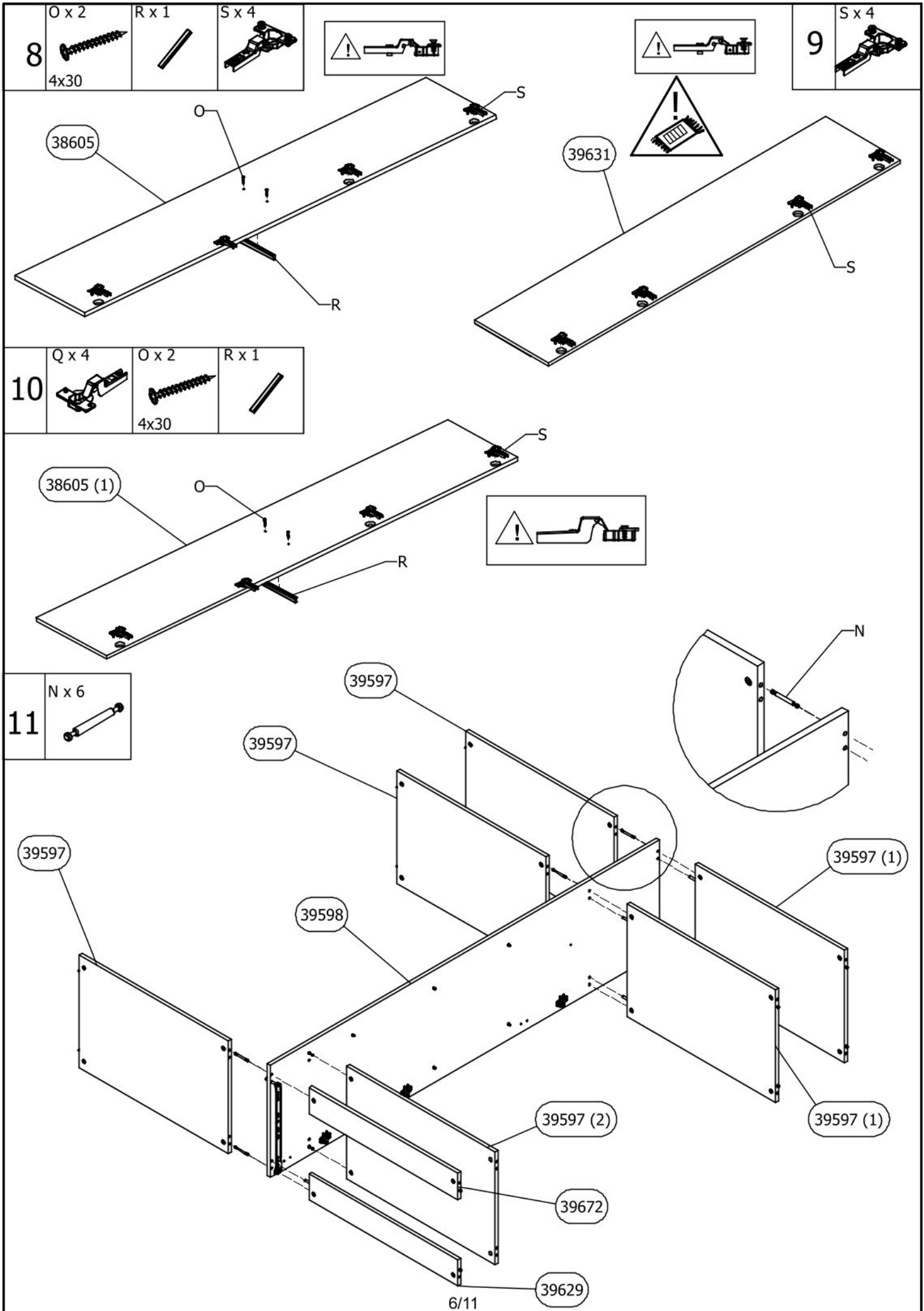

12

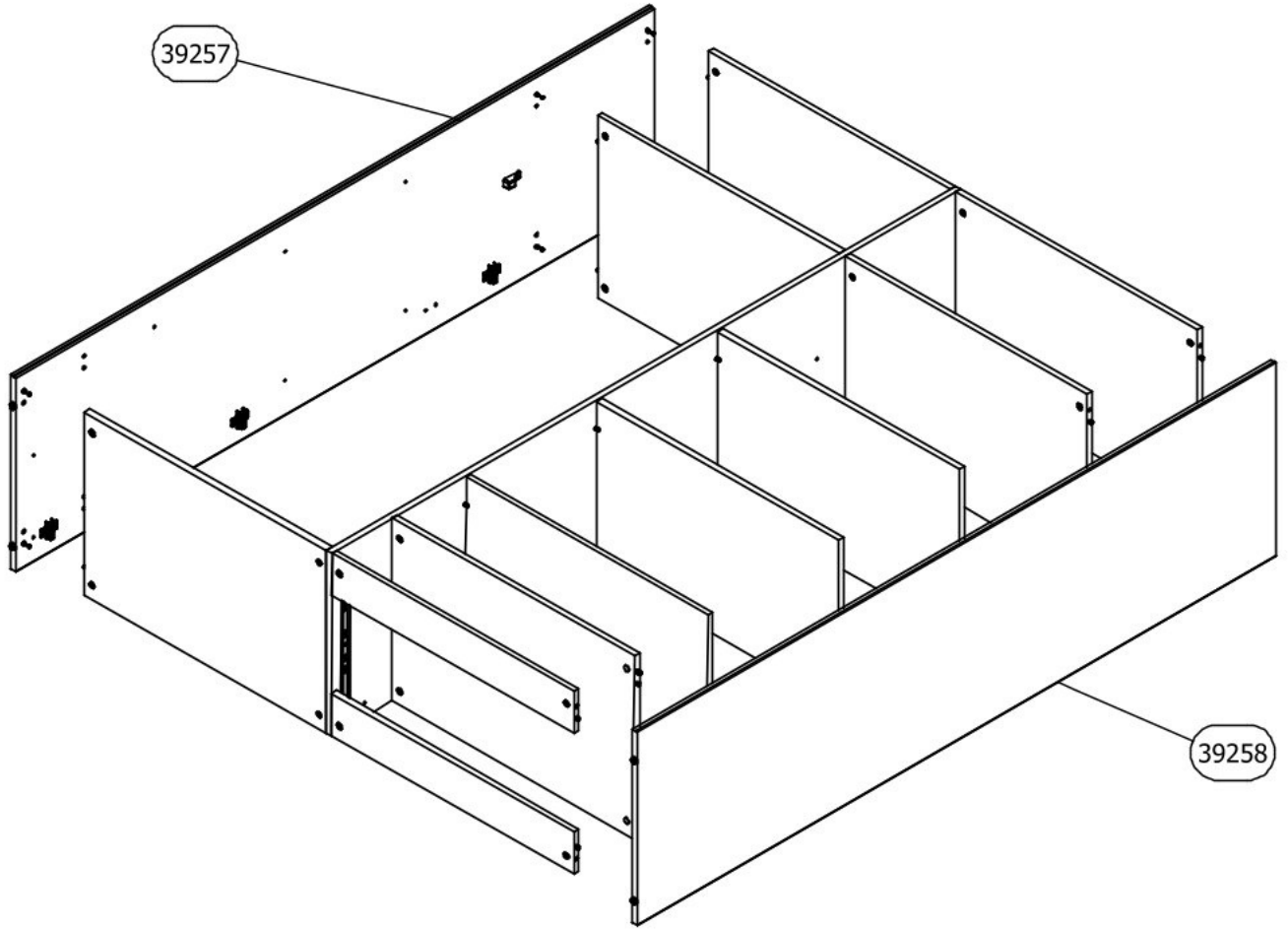

13

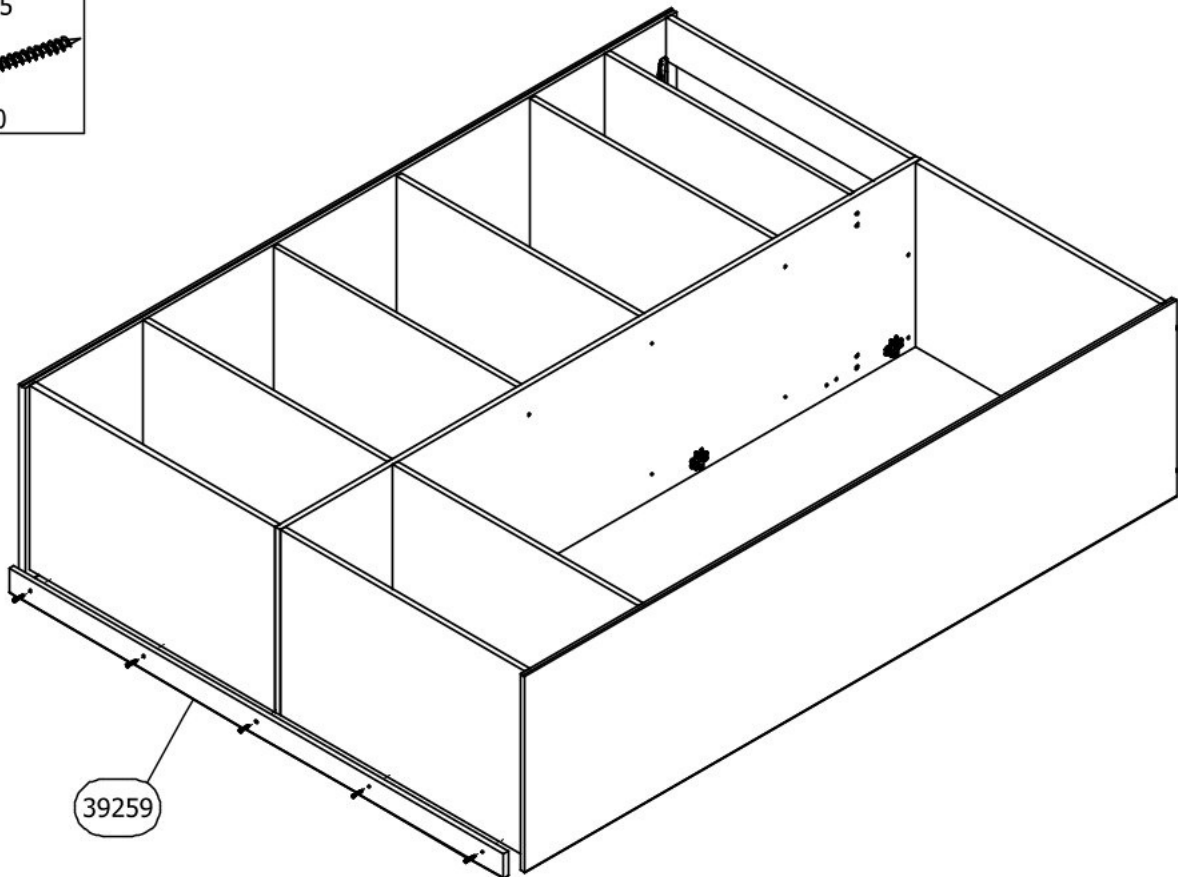

14

Y x 2



Z x 4



4x30

U x 30

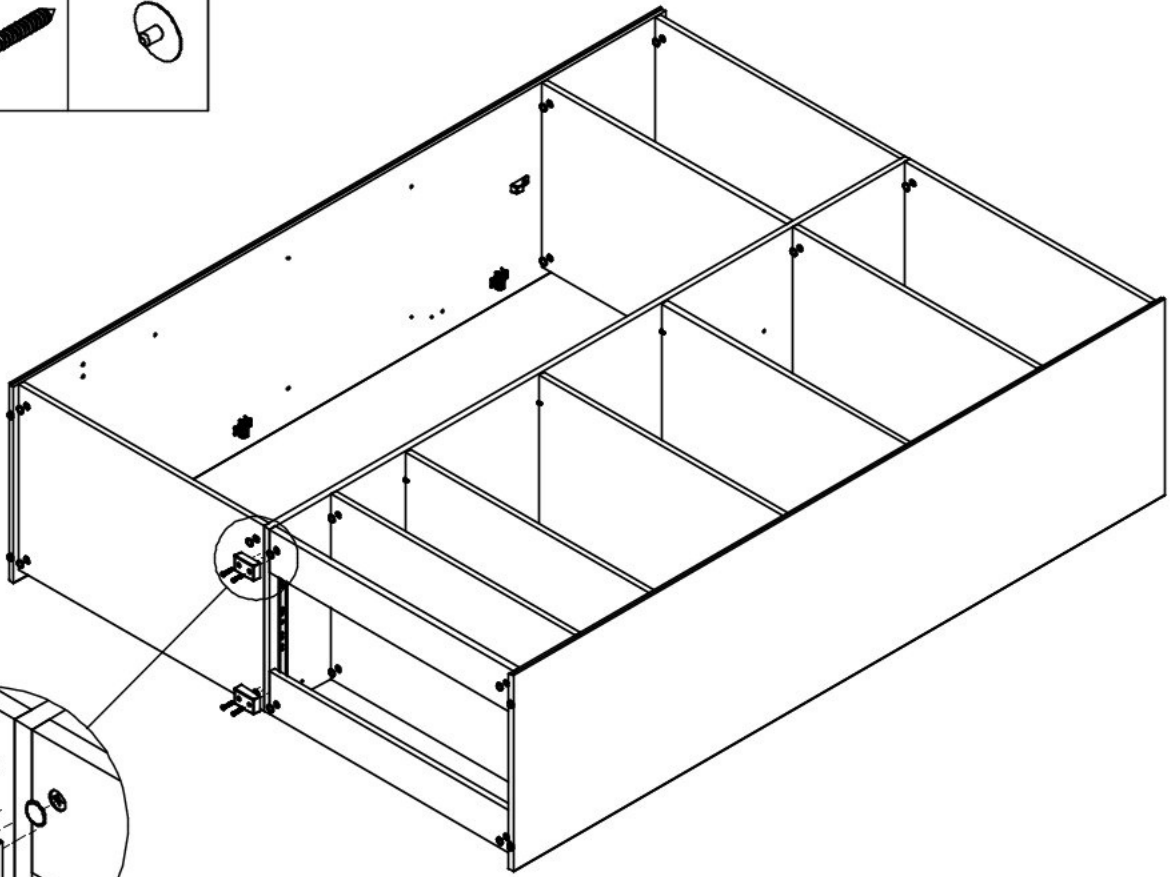
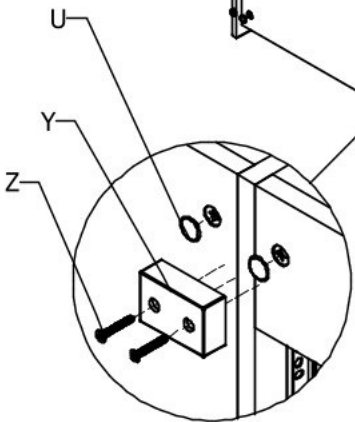

15

Ad x 10



W x 10



3x25

Ae x 54



1.6 x 25

38608

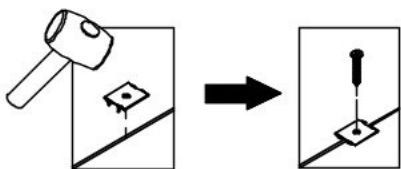
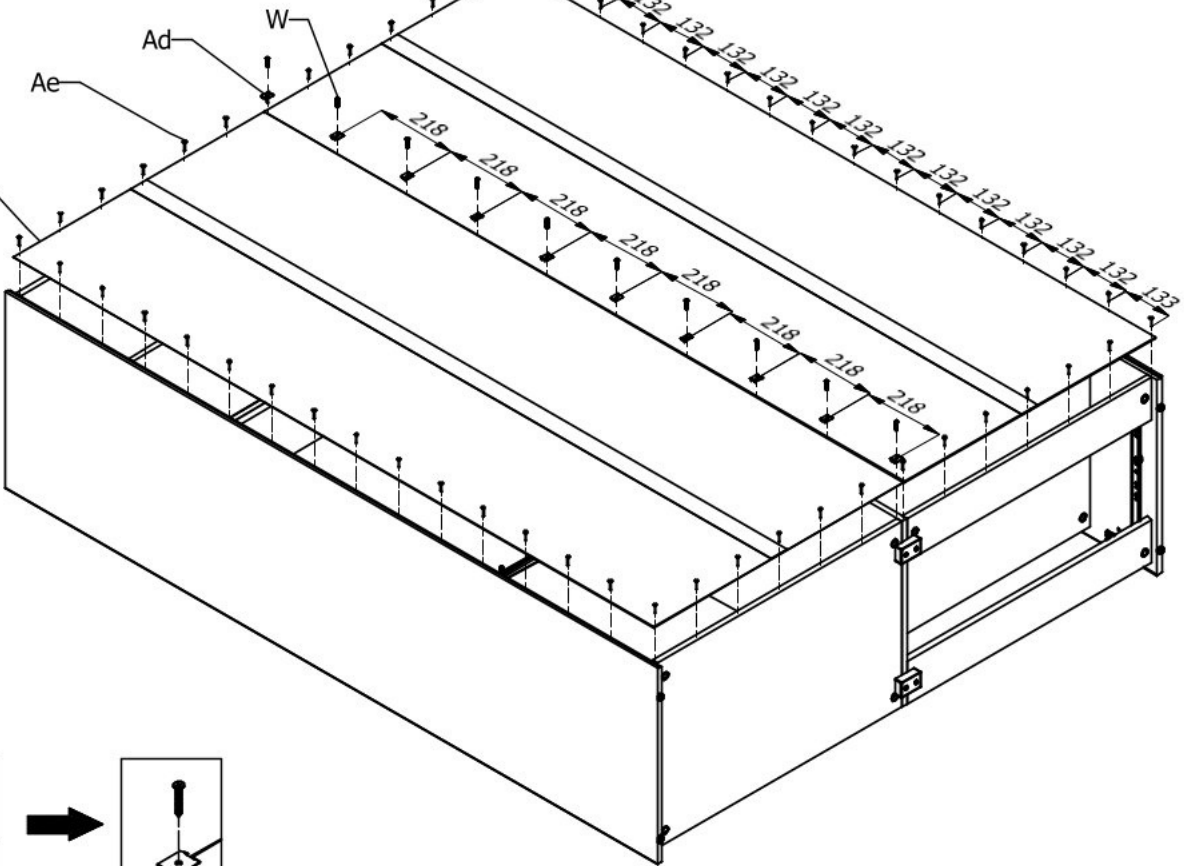

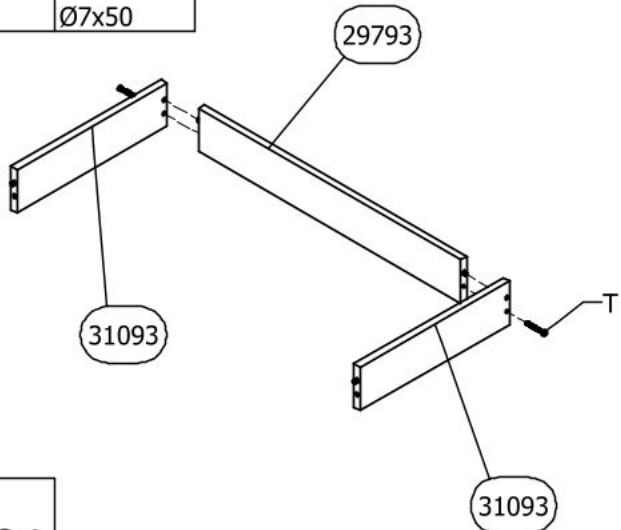
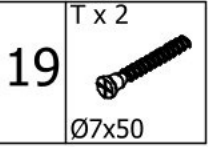
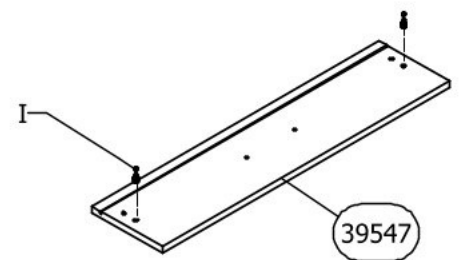
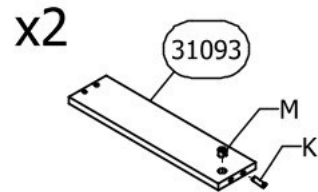
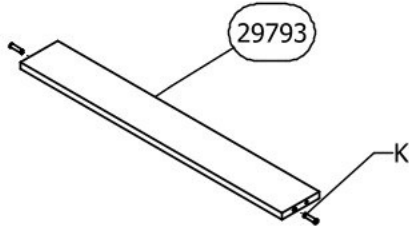
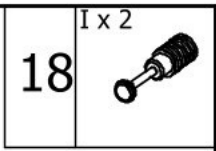
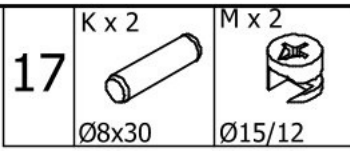
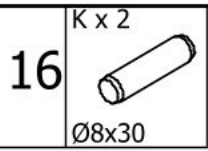

20

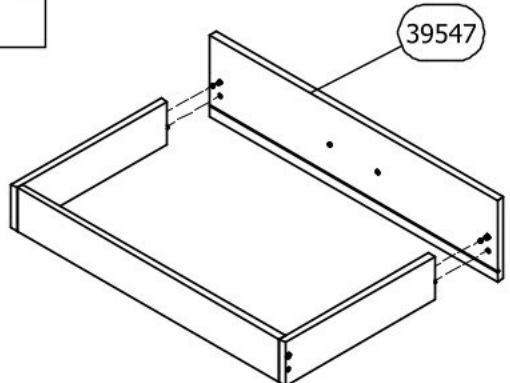

21

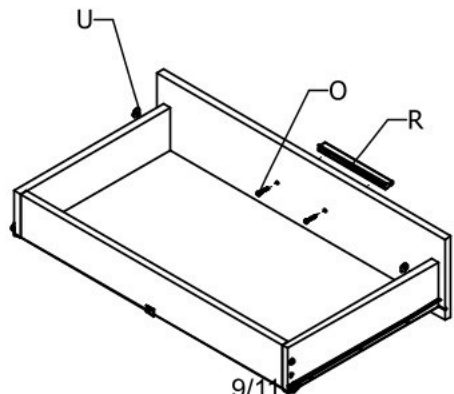
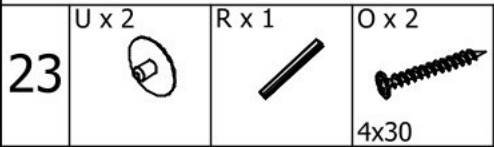
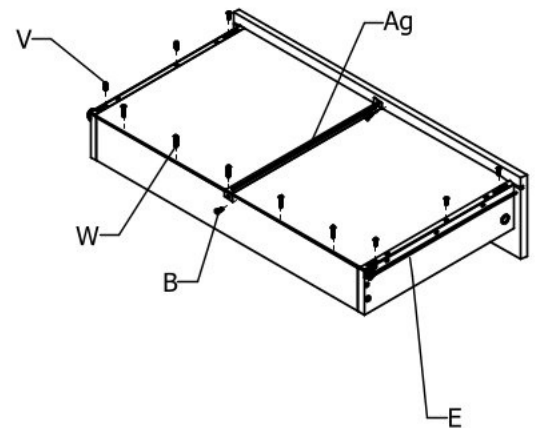
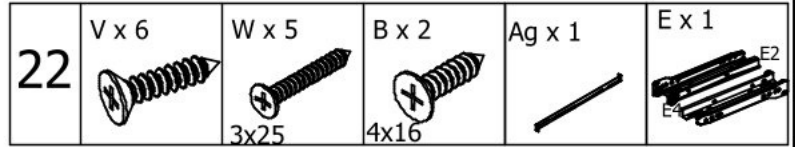
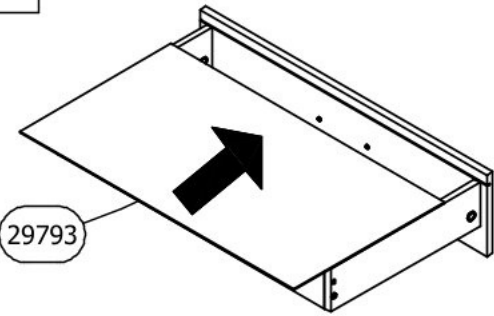

24

Ah x 1

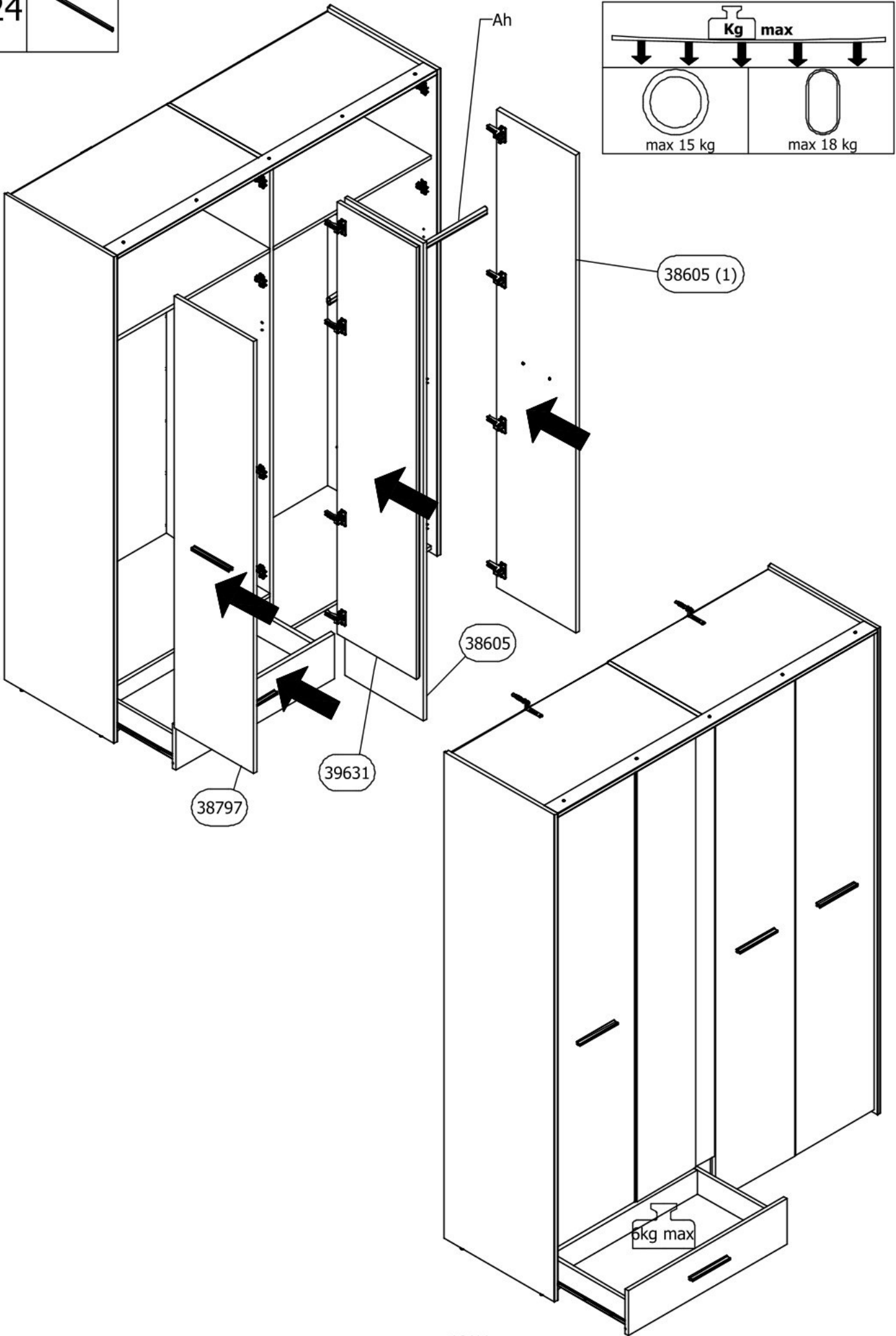

25

26

Aa x 2

Ab x 2

Ac x 2

B x 4

Af x 1

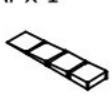
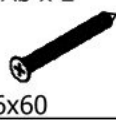

6x60

4x16

